

INOX PACK®

DIVISIONE GRANDI IMPIANTI

ARCA
CUCINE
I T A L I A



Banchi Alimentari
Food Counter

Duna

LA TRASPARENZA
DEL VETRO E DELLE
STRUTTURE...
PER ESALTARE IL
VOSTRO PRODOTTO.

THE TRANSPARENCY
OF THE GLASS
AND OF THE STRUCTURES...
TO EXALT YOUR PRODUCT

LA TRANSPARENCE DU VERRE ET
DES STRUCTURES...
POUR EXALTER VOTRE PRODUIT



Duna



Duna



Duna

PER TRASMETTERE UNA CONTINUITÀ DI SAPORI
TO TRANSMIT A CONTINUITY OF TASTES
POUR TRANSMETTRE UNE CONTINUITÉ DE GOÛTS



Duna

LA COMPLETEZZA DEGLI ELEMENTI PER UN SERVIZIO IMPECCABILE
THE COMPLETENESS OF THE ELEMENTS FOR AN IMPECCABLE SERVICE
LE CARACTÈRE EXHAUSTIF DES ÉLÉMENTS POUR UN SERVICE IMPECCABLE



Madi

PER TRANQUILLITÀ
E CERTEZZA ...
NELLA SPESA
DI TUTTI I GIORNI

FOR CALM AND CER-
TAINTY...
IN THE EXPENSE OF
EVERY DAY

POUR TRANQUILLITÉ ET
CERTITUDE...
DANS LA DÉPENSE DE
TOUS LES JOURS



Madi



Oasi

PER PRENDERE...
SCEGLIERE...
E PORTAR VIA...

TO TAKE...
TO CHOOSE AND TO
BRING AWAY

POUR PRENDRE...
CHOISIR...
ET PORTER...





Format Self

PER MOSTRARE IL VOSTRO PRODOTTO
DA VICINO....
E AIUTARE A SCEGLIERE!!

TO SHOW NEARBY YOUR PRODUCT
AND TO HELP TO CHOOSE

POUR MONTRER VOTRE PRODUIT DE PRÈS....
ET AIDER À CHOISIR





Quadra

natura
tradizione

sapori
profumi

freschezza
benessere

sapo
profumi
leggerez



Quadra

PER UN MINIMALISMO A FORTE IMPATTO
FOR A MINIMALISM TO STRONG IMPACT
POUR UN MINIMALISME AU FORT IMPACT







Retrobanchi

PER UNA LAVORAZIONE ARTIGIANALE
CHE VESTE E SVESTE!!

FOR A HANDCRAFT WORKMANSHIP THAT DRESSES
AND UNDRESSES!!

POUR UN TRAVAIL ARTISANAL QUI VÊTEMENT ET IL
DÉSHABILLE!!







MODULARITA' E ROBUSTEZZA...
PER LA LAVORAZIONE ED IL CONFEZIONAMENTO!

MODULARITY AND STURDINESS...
FOR THE WORKMANSHIP IT IS THE PREPARATION

MODULARITA' ET ROBUSTESSE...
POUR LE TRAVAIL ET POUR LA PRÉPARATION



schede tecniche linea DUNA

technical cards

fiches techniques

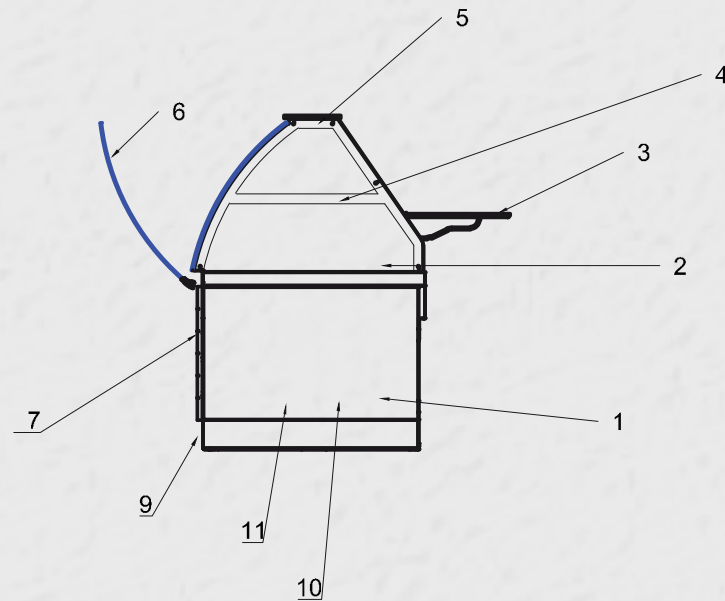

1. VASCA RACCOLTA CONDENSA
2. EVAPORATORE CON VALVOLA DI ESPANSIONE R404A
3. PIANO DI LAVORO
4. MONTANTI IN PLEXYGLASS
5. ILLUMINAZIONE CON TUBO FLUORESCENTE CON LUCE FREDDA/LED AD ALTA LUMINOSITÀ OPZIONALE
6. VETRO TEMPRATO APRIBILE VERSO IL BASSO
7. FRONTALE PERSONALIZZABILE IN LAMINATO DI LEGNO O ACCIAIO
9. BATTISCOPA IN ACCIAIO
10. REFRIGERAZIONE STATICA
11. UNITÀ MOTOCONDENSANTE

1. BOWL HARVEST CONDENSES
2. EVAPORATOR WITH VALVE OF EXPANSION
3. WORK TOP
4. UPRIGHT IN PLEXYGLASS
5. ILLUMINATION WITH FLUORESCENT PIPE TO COLD LIGHT / LED HIGH BRIGHTNESS OPTIONAL
6. GLASS WITH OPENING TOWARD THE LOWER PART
7. FRONT PERSONALIZED IN WOOD OR STEEL
9. SKIRTING-BOARD IN S/S OR WOOD
10. STATIC REFRIGERATION
11. CONDENSING UNIT

1. VASQUE RECUEILLIE BUÉE
2. EVAPORER R AVEC SOUPEPE D'EXPANSION
3. PLAN DE TRAVAIL
4. MONTANT EN PLEXYGLASS
5. ÉCLAIRAGE AVEC TUYAU FLUORESCENT AVEC LUMIÈRE FROIDE / HAUTE LUMINOSITÉ OPZIONALE
6. VERRE AVEC OUVERTURE VERS LE BAS
7. FRONTAIL PERSONNALISÉ EN BOIS OU ACIER
9. PHLINTE EN ACIER O BOIS
10. RÉFRIGÉRATION STATIQUE
11. UNITE' DE CONDENSATION

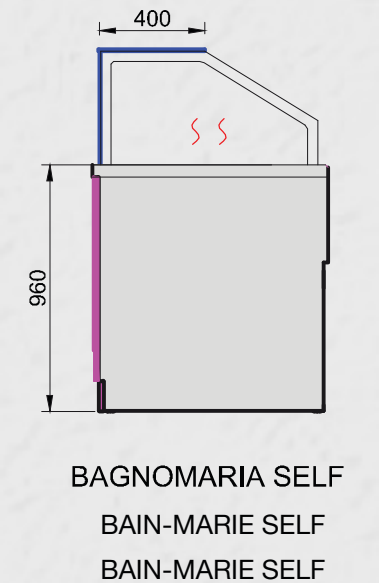
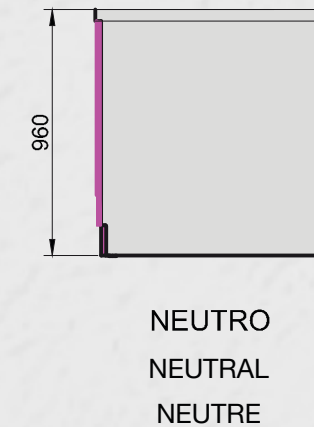
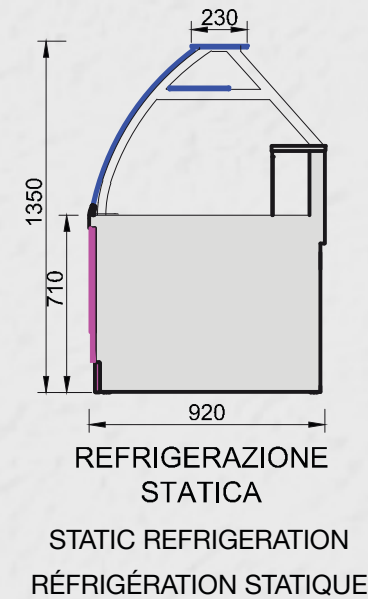

FINITURE IN LAMINATO DI LEGNO

FINITION EN LAMINÉ DE BOIS

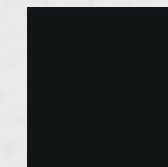

NERO
BLACK
NOIR

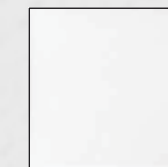

BIANCO
WHITE
BLANC



ROSSO
RED
ROUGE

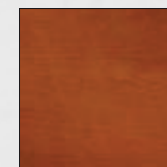

CILIEGIO
CHERRY
CERISIER



ROVERE
OAK
ROUVRE

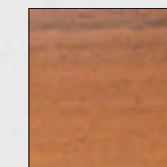

NOCA
WALNUT
NOIX

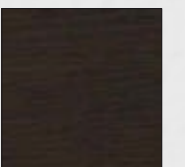

WENGE'

schede tecniche linea MADI

technical cards

fiches techniques

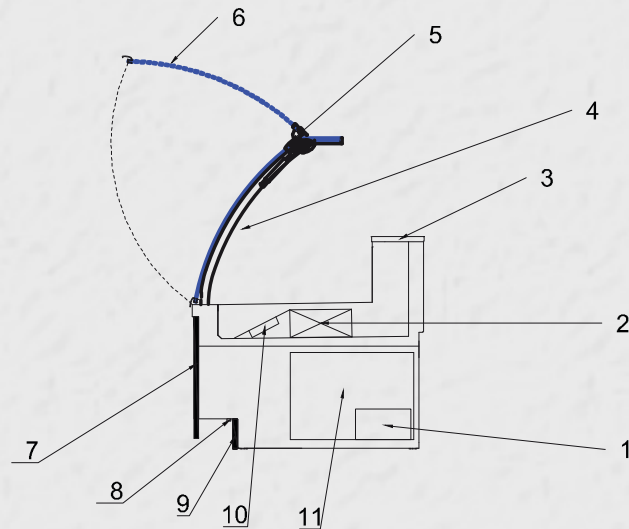

1. VASCA RACCOLTA CONDENSA
2. EVAPORATORE CON VALVOLA DI ESPANSIONE R404A
3. PIANO DI LAVORO IN ACCIAIO ANTIGRAFFIO DECOR
4. MONTANTI IN ALLUMINIO
5. ILLUMINAZIONE CON TUBO FLUORESCENTE CON LUCE FREDDA/LED AD ALTA LUMINOSITÀ OPZIONALE
6. VETRO TEMPRATO PISTONABILE APRIBILE DALL'ALTO
7. FRONTALE PERSONALIZZABILE IN LAMINATO DI LEGNO O ACCIAIO
8. ILLUMINAZIONE BATTISCOPIA A LED
9. BATTISCOPIA IN ACCIAIO INDIETREGGIATO FRONTALMENTE E LATERALMENTE
10. REFRIGERAZIONE VENTILATA O STATICA
11. UNITÀ MOTOCONDENSANTE

1. BOWL HARVEST CONDENSES
2. EVAPORATOR WITH VALVE OF EXPANSION
3. WORK TOP IN STAINLESS STEEL ANTI SCRATCH
4. UPRIGHT IN PLEXYGLASS
5. ILLUMINATION WITH FLUORESCENT PIPE TO COLD LIGHT / LED HIGH BRIGHTNESS OPTIONAL
6. GLASS WITH LATERAL OPENING
7. FRONT PERSONALIZED IN WOOD OR STEEL
8. SKIRTING-BOARD IN S/S OR WOOD WITH LWD LIGHTING
9. SKIRTING BOARD WITH RECESS IN FRONT AND SIDE
10. STATIC REFRIGERATION OR VENTILATED
11. CONDENSING UNIT

1. VASQUE RECUEILLIE BUÉE
2. EVAPORER R AVEC SOUPAPE D'EXPANSION
3. PLAN DE TRAVAIL EN ACIER ANTI GRATIGNURE
4. MONTANT EN PLEXYGLASS
5. ÉCLAIRAGE AVEC TUYAU FLUORESCENT AVEC LUMIÈRE FROIDE / HAUTE LUMINOSITÉ OPTIONAL
6. VERRE AVEC OUVERTURE LATERAL
7. FRONTAIL PERSONNALISÉ EN BOIS OU ACIER
8. PHLINTE EN ACIER O BOIS ECLAIRAGE A LED
9. PHLINTE AVEC RENFORCEMENT FRONTAL ET LATERALE
10. RÉFRIGÉRATION STATIQUE OU VENTILÉE
11. UNITE' DE CONDENSATION

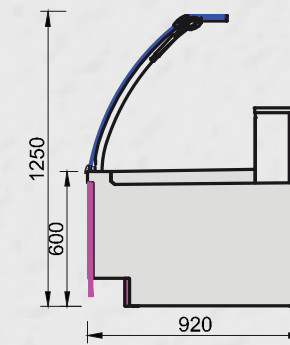

REFRIGERAZIONE VENTILATA
VENTILATED REFRIGERATION
RÉFRIGÉRATION VENTILÉE

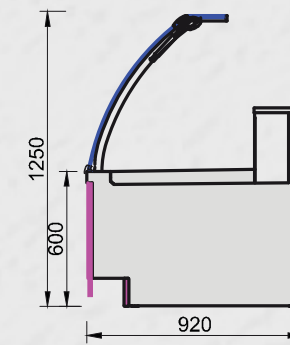

REFRIGERAZIONE STATICA
STATIC REFRIGERATION
RÉFRIGÉRATION STATIQUE

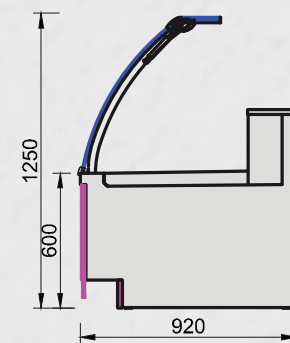

NEUTRO
NEUTRAL
NEUTRE

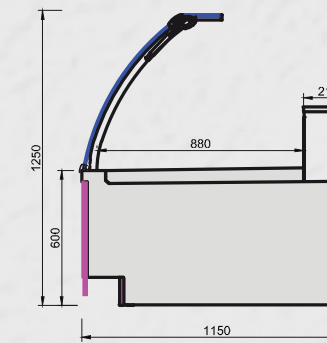

REFRIGERAZIONE VENTILATA
VENTILATED REFRIGERATION
RÉFRIGÉRATION VENTILÉE

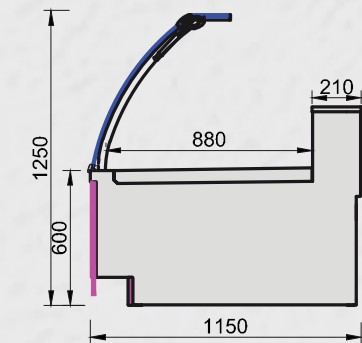

NEUTRO
NEUTRAL
NEUTRE

FINITURE IN LAMINATO DI LEGNO

FINISHING IN ROLLED WOOD
FINITION EN LAMINÉ DE BOIS

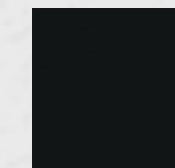

NERO
BLACK
NOIR



BIANCO
WHITE
BLANC



ROSSO
RED
ROUGE

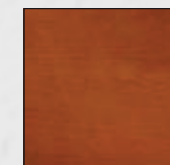

CILIEGIO
CHERRY
CERISIER



ROVERE
OAK
ROUVRE

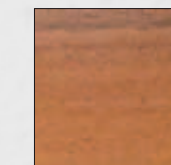

NOCA
WALNUT
NOIX

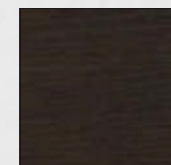

WENGE'

schede tecniche linea QUADRA

technical cards

fiches techniques

ANGOLI

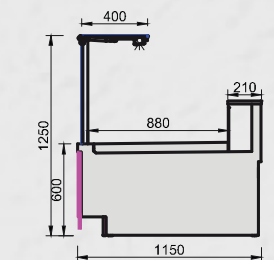

REFRIGERAZIONE VENTILATA
VENTILATED REFRIGERATION
RÉFRIGÉRATION VENTILÉE

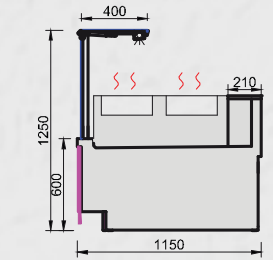

BAGNOMARIA
BAIN-MARIE
BAIN-MARIE

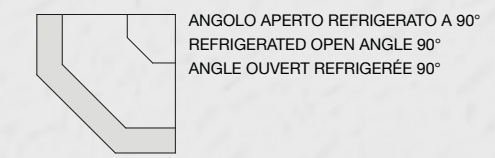

ANGOLO APERTO REFRIGERATO A 90°
REFRIGERATED OPEN ANGLE 90°
ANGLE OUVERT REFRIGÉRÉE 90°

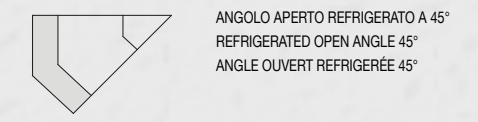

ANGOLO APERTO REFRIGERATO A 45°
REFRIGERATED OPEN ANGLE 45°
ANGLE OUVERT REFRIGÉRÉE 45°



ANGOLO APERTO REFRIGERATO A 45°
REFRIGERATED OPEN ANGLE 45°
ANGLE OUVERT REFRIGÉRÉE 45°

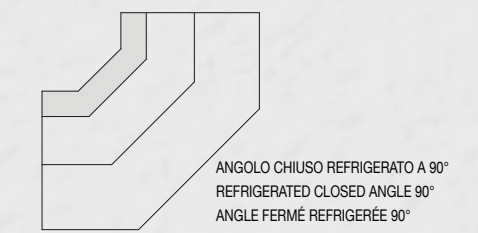

ANGOLO CHIUSO REFRIGERATO A 90°
REFRIGERATED CLOSED ANGLE 90°
ANGLE FERMÉ REFRIGÉRÉE 90°

LINEA QUADRA 115p

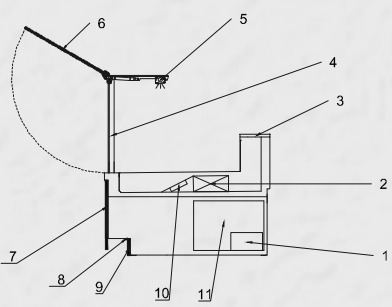

- | | | |
|---|--|--|
| <ol style="list-style-type: none"> 1. VASCA RACCOLTA CONDENSA 2. EVAPORATORE CON VALVOLA DI ESPANSIONE R404A 3. PIANO DI LAVORO IN ACCIAIO ANTIGRAFFIO DECOR 4. MONTANTI IN ALLUMINIO 5. ILLUMINAZIONE CON TUBO FLUORESCENTE CON LUCE FREDDA/LED AD ALTA LUMINOSITÀ OPZIONALE 6. VETRO TEMPRATO PISTONATO APRIBILE DALL'ALTO 7. FRONTALE PERSONALIZZABILE IN LAMINATO DI LEGNO O ACCIAIO 8. ILLUMINAZIONE BATTISCOPA A LED 9. BATTISCOPA IN ACCIAIO INDIETREGGIATO FRONTALMENTE E LATERALMENTE 10. REFRIGERAZIONE VNTILATA 11. UNITÀ MOTOCONDENSANTE | <ol style="list-style-type: none"> 1. BOWL HARVEST CONDENSES 2. EVAPORATOR WITH VALVE OF EXPANSION 3. WORK TOP IN STAINLESS STEEL ANTI SCRATCH 4. UPRIGHT IN PLEXYGlass 5. ILLUMINATION WITH FLUORESCENT PIPE TO COLD LIGHT / LED HIGH BRIGHTNESS OPTIONAL 6. GLASS WITH LATERAL OPENING 7. FRONT PERSONALIZED IN WOOD OR STEEL 8. SKIRTING-BOARD IN S/S OR WOOD WITH LWD LIGHTING 9. SKIRTING BOARD WITH RECESS IN FRONT AND SIDE 10. STATIC REFRIGERATION 11. CONDENSING UNIT | <ol style="list-style-type: none"> 1. VASQUE RECUEILLIE BUÉE 2. EVAPORER R AVEC SOUPAPE D'EXPANSION 3. PLAN DE TRAVAIL EN ACIER ANTI GRATIGNURE 4. MONTANT EN PLEXYGlass 5. ÉCLAIRAGE AVEC TUYAU FLUORESCENT AVEC LUMIÈRE FROIDE / HAUTE LUMINOSITÉ OPTIONAL 6. VERRE AEC DES PISTONS OUVERTURE DU HAUT 7. FRONTAIL PERSONNALIZZABILE EN BOIS OU ACIER 8. ECLAIRAGE A LED DU PHLINTE 9. PHLINTE AVEC RENFORCEMENT FRONTAL ET LATERALE 10. RÉFRIGÉRATION STATIQUE OU VENTILÉE 11. UNITE' DE CONDENSATION |
|---|--|--|

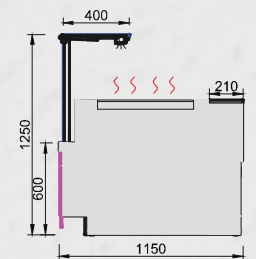

CALDO SECCO
DRY HEAT
CHALEUR SÈCHE

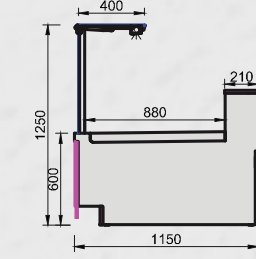

NEUTRO
NEUTRAL
NEUTRE

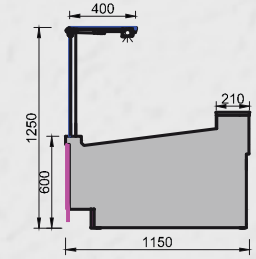

REFRIGERAZIONE CON SERPENTINA
A CONTATTO PER PESCE
REFRIGERATION WITH COIL
TO CONTACT FOR FISH
RÉFRIGÉRATION AVEC SERPENTINE
AU CONTACT POUR POISSON

LINEA QUADRA 92p

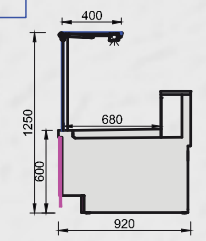

REFRIGERAZIONE VENTILATA
VENTILATED REFRIGERATION
RÉFRIGÉRATION VENTILÉE

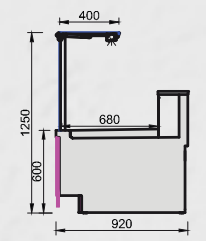

REFRIGERAZIONE STATICA
STATIC REFRIGERATION
RÉFRIGÉRATION STATIQUE

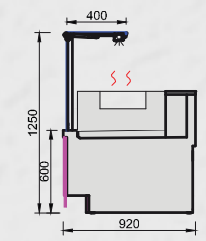

BAGNOMARIA
BAIN-MRIE SELF
BAIN-MARIE SELF

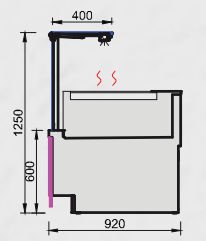

CALDO SECCO
DRY HEAT
CHALEUR SÈCHE

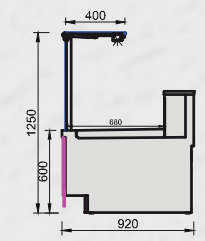

NEUTRO
NEUTRAL
NEUTRE

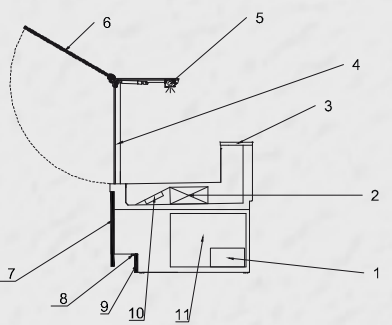

- | | | |
|--|--|---|
| <ol style="list-style-type: none"> 1. VASCA RACCOLTA CONDENSA 2. EVAPORATORE CON VALVOLA DI ESPANSIONE R404A 3. PIANO DI LAVORO IN ACCIAIO ANTIGRAFFIO DECOR 4. MONTANTI IN ALLUMINIO 5. ILLUMINAZIONE CON TUBO FLUORESCENTE CON LUCE FREDDA/LED AD ALTA LUMINOSITÀ OPZIONALE 6. VETRO TEMPRATO PISTONABILE APRIBILE DALL'ALTO 7. FRONTALE PERSONALIZZABILE IN LAMINATO DI LEGNO O ACCIAIO 8. ILLUMINAZIONE BATTISCOPA A LED 9. BATTISCOPA IN ACCIAIO INDIETREGGIATO FRONTALMENTE E LATERALMENTE 10. REFRIGERAZIONE VENTILATA O STATICA 11. UNITÀ MOTOCONDENSANTE | <ol style="list-style-type: none"> 1. BOWL HARVEST CONDENSES 2. EVAPORATOR WITH VALVE OF EXPANSION 3. WORK TOP IN STAINLESS STEEL ANTI SCRATCH 4. UPRIGHT IN PLEXYGlass 5. ILLUMINATION WITH FLUORESCENT PIPE TO COLD LIGHT / LED HIGH BRIGHTNESS OPTIONAL 6. GLASS WITH LATERAL OPENING 7. FRONT PERSONALIZED IN WOOD OR STEEL 8. SKIRTING-BOARD IN S/S OR WOOD WITH LWD LIGHTING 9. SKIRTING BOARD WITH RECESS IN FRONT AND SIDE 10. STATIC REFRIGERATION OR VENTILATED 11. CONDENSING UNIT | <ol style="list-style-type: none"> 1. VASQUE RECUEILLIE BUÉE 2. EVAPORER R AVEC SOUPAPE D'EXPANSION 3. PLAN DE TRAVAIL EN ACIER ANTI GRATIGNURE 4. MONTANT EN PLEXYGlass 5. ÉCLAIRAGE AVEC TUYAU FLUORESCENT AVEC LUMIÈRE FROIDE / HAUTE LUMINOSITÉ OPTIONAL 6. VERRE AVEC OUVERTURE LATERAL 7. FRONTAIL PERSONNALISÉ EN BOIS OU ACIER 8. PHLINTE EN ACIER O BOIS ECLAIRAGE A LED 9. PHLINTE AVEC RENFORCEMENT FRONTAL ET LATERALE 10. RÉFRIGÉRATION STATIQUE OU VENTILÉE 11. UNITE' DE CONDENSATION |
|--|--|---|

FINITURE IN LAMINATO DI LEGNO

FINISHING IN ROLLED WOOD
FINITION EN LAMINÉ DE BOIS

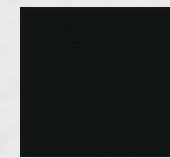

NERO
BLACK
NOIR

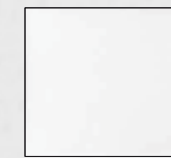

BIANCO
WHITE
BLANC



ROSSO
RED
ROUGE

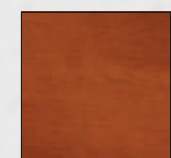

CILIEGIO
CHERRY
CERISIER



ROVERE
OAK
ROUVRE

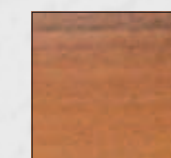

NOCA
WALNUT
NOIX

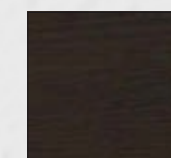

WENGE'

schede tecniche linea FORMAT

technical cards

fiches techniques

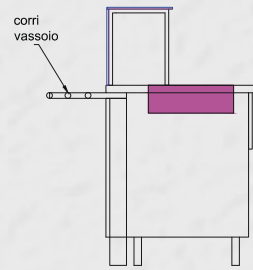
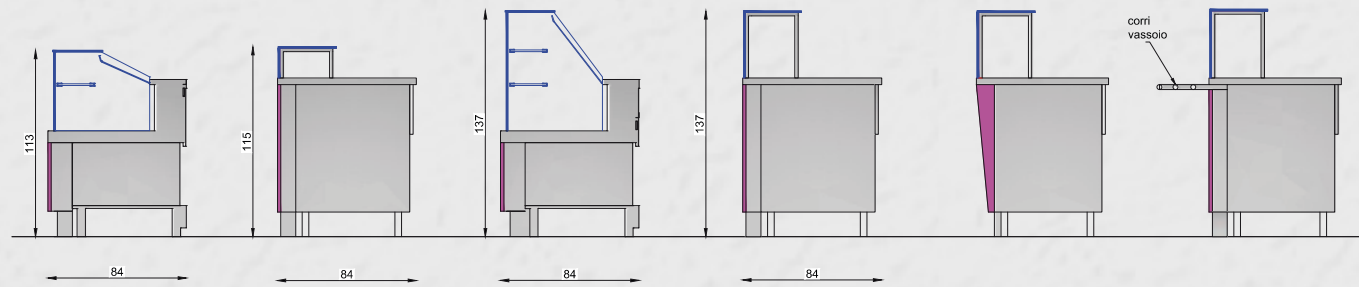

PIANO BAGNOMARIA
INSERIMENTO PER MODULI L.100
/ 125 / 150cm

BAIN-MARIE PLAN FOR MODUL
100/ 125/150

PLAN BAIN-MARIE POUR
MODULES 100/125/150

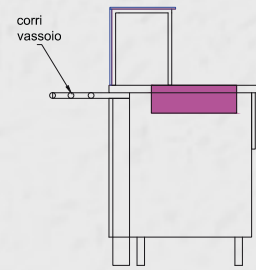

PIANO FREDDO VENTILATO
INSERIMENTO PER MODULI L.100
/ 125 / 150cm

VENTILETED COLD PLAN FOR
MODUL 100/125/150

PLAN FROID VENTILEE POUR
ELEMENT 100/125/150

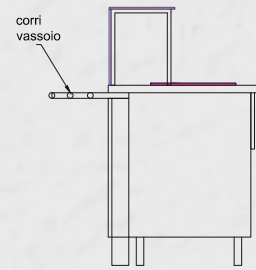

PIANO FREDDO A CONTATTO
INSERIMENTO PER MODULI L.100
/ 125 / 150cm

COLD PLAN TO CONTACT FOR
MODUL 100/125/150

PLAN FROID A CONTACT POUR
ELEMENT 100/125/150

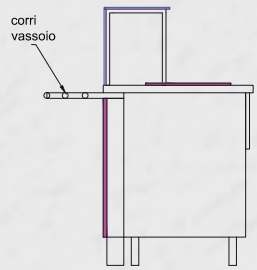

PIANO CALDO SECCO
INSERIMENTO PER MODULI L.100
/ 125 / 150cm

DRY HEAT PLAN FOR MODUL
100/125/150

PLAN FROID A CONTACT
POUR ELEMENT 100/125/150

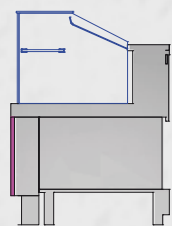

VETRINA FREDDO VENTILATO
VETRI BASSI DIRITTI
L.100 / 125 / 150cm

VENTILATED COLD
DISPLAY LOW STRIGHT
GLASSES 100/125/150

VERRES BASSES
100/125/150

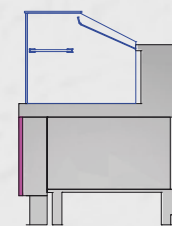

VETRINA FREDDO STATICO
VETRI BASSI DIRITTI
L.100 / 125 / 150cm

COLD STATIC DISPLAY
STRIGHT LOW
GLASSES
100/125/150

ETAL FROID STATIC
VERRES BASSES
100-125/150

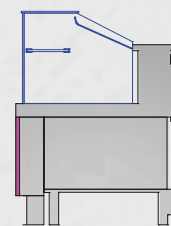

VETRINA CALDO SECCO
VETRI BASSI DIRITTI
L.100 / 125 / 150cm

DRY HEAT DISPLAY
STRIGHT LOW
GLASSES
100/125/150

ETAL CHAUD SEC
VERRES BASSES
100/125/150

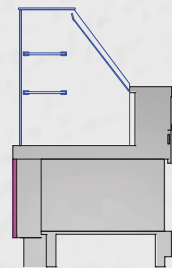

VETRINA FREDDO VENTILATO
VETRI ALTI DIRITTI
L.100 / 125 / 150cm

VENTILATED COLD
DISPLAY HIGH STRIGHT
GLASSES 100/125/150

VERRES HAUTS
100/125/150

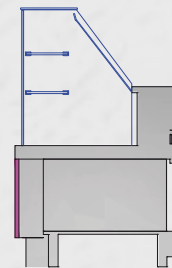

VETRINA FREDDO STATICO
VETRI ALTI DIRITTI
L.100 / 125 / 150cm

COLD STATIC DISPLAY
STRIGHT HIGH
GLASSES
100/125/150

ETAL FROID STATIC
VERRES HAUTS
100-125/150

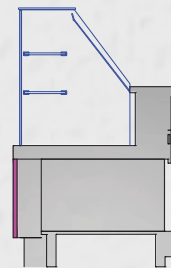

VETRINA CALDO SECCO
VETRI ALTI DIRITTI
L.100 / 125 / 150cm

DRY HEAT DISPLAY
HIGH STRIGHT
GLASSES 100/125/150

ETAL CHAUD SEC
VERRES HAUTES
100/125/150

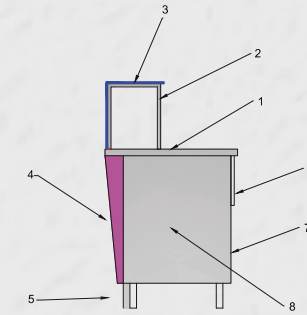
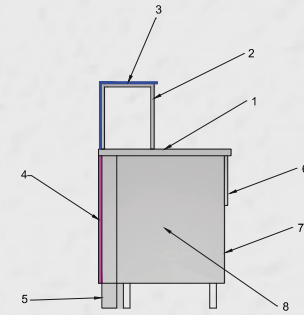

1. PIANO DI LAVORO IN ACCIAIO INOX AISI 304 FINITURA SCOTCH BRITE
2. REGGI PIANO VETRO IN ACCIAIO INOX AISI 304 FINITURA SCOTCH BRITE
3. VETRO TEMPERATO
4. RIVESTIMENTO IN LAMINATO DI LEGNO
5. ZOCCOLO IN ACCIAIO INOX AISI 304 FINITURA SCOTCH BRITE
7. VANO A GIORNO PER UNITÀ CONDENSATRICE
8. STRUTTURA DEL MODULO IN ACCIAIO INOX AISI 304 FINITURA SCOTCH BRITE

- 1 WORK TOP IN STAINLESS STEEL AISI 304 SCOTCH BRITE
- 2 S/S SUPPORT FOR GLASS PLAN
- 3 TEMPER GLASS
- 4 COVERING IN LAMINATED WOOD
- 5 PLINTH IN STAINLESS STEEL 304 AISI SCOTCH BRITE
- 6 UPRIGHT
- 7 OPENING FOR CONDENSING UNIT
- 8 STRUCTURE ELEMENT IN STAINLESS STEEL 304 SCOTCH BRITE

- 1 PLAN DE TRAVAIL EN ACIER 304 AISI SCOTCH BRITE
- 2 SUPPORT EN ACIER POUR PLAN EN VERRE
- 3 VERRE TEMPÉRÉ
- 4 REVÊTEMENT EN BOIS LAMINÉ
- 5 PLINTE EN ACIER INOX SCOTCH BRITE
- 6 MONTANT
- 7 CAGE OUVERT POUR UNITE DE CONDENSATION
- 8 STRUCTURE ÉLÉMENTS EN ACIER 304 AISI SCOTCH BRITE

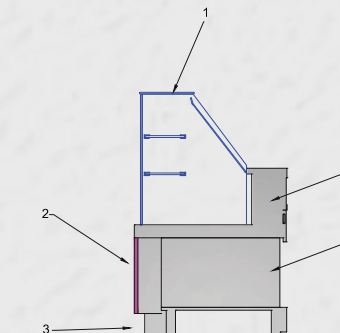
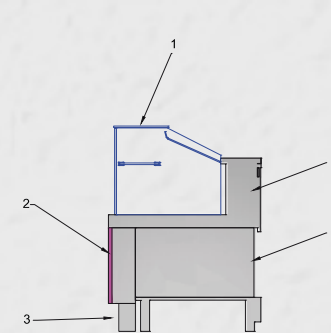

1. CASTELLO CON VETRI TEMPERATI
2. ROVESTIMENTO IN LAMINATO DI LEGNO
3. ZOCCOLO IN ACCIAIO INOX AISI 304 FINITURA SCOTCH BRITE
4. VASCA IN ACCIAIO INOX AISI 304 FINITURA SCOTCH BRITE
5. VANO A GIORNO PER UNITÀ CONDENSATRICE

- 1 GLASS CASTLE
- 2 COVERING IN ROLLED WOOD
- 3 PHLINT IN STAINLESS STEEL AISI 304 SCOTCH BRITE
- 4 BOWL IN STAINLESS STEEL 304 SCOTCH BRITE
- 5 OPENING FOR CONDENSING UNIT

1. STRUCTURE EN VERRES
2. REVÊTEMENT EN BOIS LAMINÉ
3. PLINTHE EN ACIER INOX SCOTCH BRITE
4. CUNE EN ACIER AISI 304 SCOTCH BRITE
5. CAGE OUVERT POUR UNITE DE CONDENSATION

FINITURE IN LAMINATO DI LEGNO

FINISHING IN ROLLED WOOD
FINITION EN LAMINÉ DE BOIS

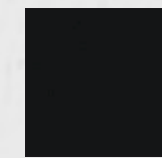

NERO
BLACK
NOIR

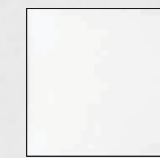

BIANCO
WHITE
BLANC

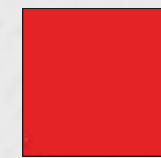

ROSSO
RED
ROUGE

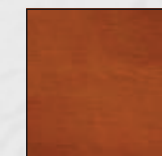

CILIEGIO
CHERRY
CERISIER



ROVERE
OAK
ROUVRE

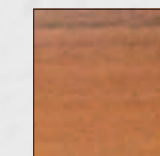

NOCA
WALNUT
NOIX

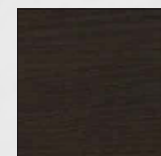

WENGE'

schede tecniche retrobanchi

technical cards

fiches techniques

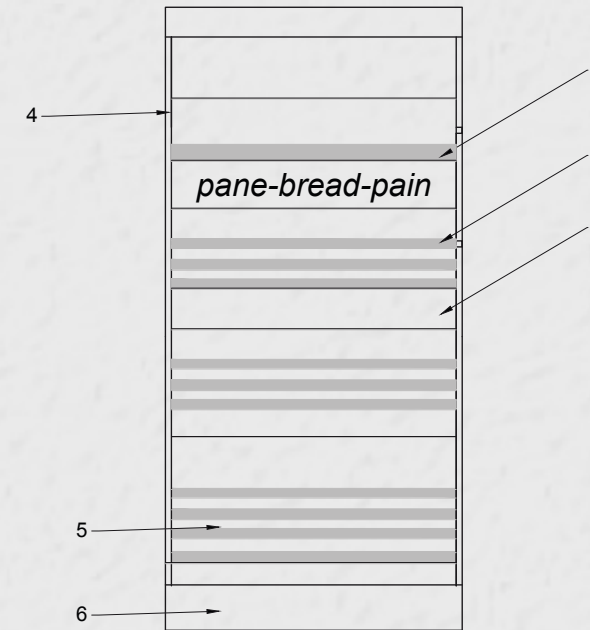
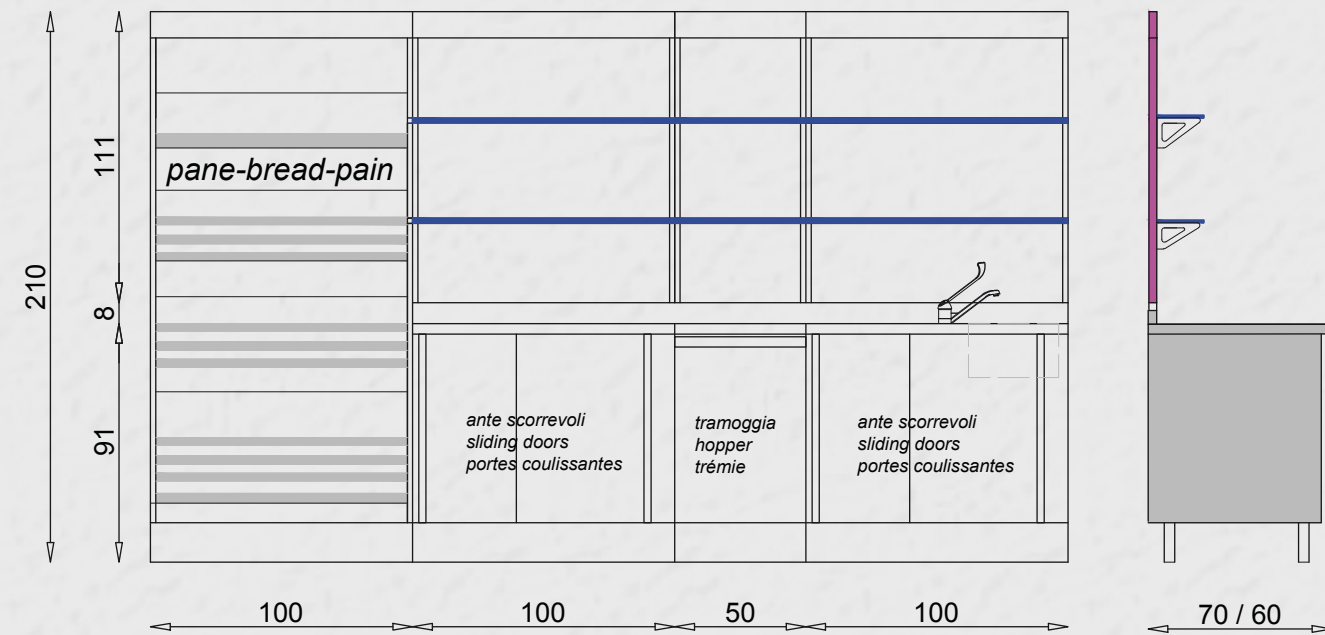

1. SCHIENA IN MULTISTRATO LAMINATO DI LEGNO
2. CESTO PANE INTERMEDIO IN LAMINATO MULTISTRATO DI LEGNO; CON INCLINAZIONE REGOLABILE E RACCOGLI BRICIOLE
3. MENSOLE IN LAMINATO DI LEGNO CON INCLINAZIONE REGOLABILE
4. CREMALIERE PER LA REGOLAZIONE DELLE MENSOLE
5. CESTO GRANDE PER PANE BASE IN LAMINATO DI LEGNO
6. ZOCCOLO IN LAMINATO DI LEGNO

1. BACK PANEL IN LAMINATED WOOD
2. BREAD BASKET IN LAMINATED WOOD, WITH ADJUSTABLE TILT AND CRUMBS COLLECTOR
3. SHELF IN LAMINATED WOOD
4. RACK FOR ADJUSTMENT SHELVES
5. BIG BREAD BASKET, BASE IN LAMINATED WOOD
6. PLINTH IN LAMINATED WOOD

1. POSTERIEUR EN BOIS LAMINÉ
2. PAIN PANIER EN BOIS LAMINÉ
3. ETAGERE EN BOIS LAMINÉ
4. SUPPORT POUR REGLAGE ETAGERES
5. GROS PAIN PANIER EN BOIS LAMINÉ
6. PLINTHE EN BOIS LAMINÉ

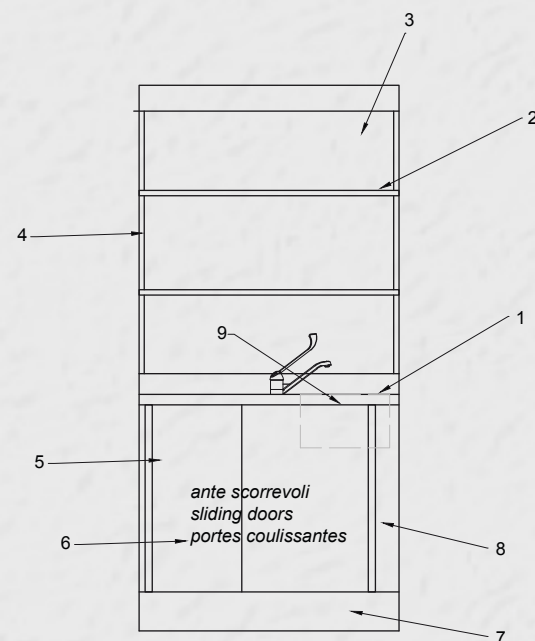

1. PIANO DI LAVORO IN ACCIAIO INOX AISI 304 FINITURA SCOTCH BRITE
2. MENSOLE IN VETRO TEMPERATO O LAMINATO DI LEGNO; TUBO ACCIAIO INOX PORTA SALUMI
3. SCHIENA IN LAMINATO DI LEGNO O SPECCHIO
4. CREMALIERE PER LA REGOLAZIONE DELLE MENSOLE
5. MODULI IN ACCIAIO INOX AISI 304 FINITURA SCOTCH BRITE, CON ANTA BATTENTE, SCORREVOLE A GIORNO E TRAMOGGIA, L. 50 / 100 / 125 / 150CM.
6. ANTE IN ACCIAIO INOX AISI 304 FINITURA SCOTCH BRITE
7. ZOCCOLO IN ACCIAIO INOX AISI 304 FINITURA SCOTCH BRITE
8. STRUTTURA DEL MODULO IN ACCIAIO INOX AISI 304 FINITURA SCOTCH BRITE
9. INSERIMENTO LAVELLO SALDATO SUL TOP VARIE DIMENSIONI

1. WORK TOP IN STAINLESS STEEL 304 SCOTCH BRITE
2. GLASS TEMPERATED SHELVES OR LAMINATED WOOD; STEEL TUBE SALAMI HOLDER
3. BACK PANEL IN LAMINATED OR MIRROR
4. RACK FOR ADJUSTMENT SHELVES
5. STAINLESS STEEL ELEMENTS AISI 304 SCOTCH BRITE WITH HANGING DOOR, SLIDINGS, AND HOPPER L. 50/100/125/150
6. DOORS IN STAINLESS STEEL AISI 304 SCOTCH BRITE
7. PLINTH IN STAINLESS STEEL AISI 304 SCOTCH BRITE
8. MODUL STRUCTURE IN ATSNLESS STEEL AISI 304 SCOTCH BRITE
9. INSERTION WELDED SINK IN THE VARIUS SIZES TOP

1. PLAN DE TRAVAIL EN ACIER SCOTCH BRITE
2. ETAGERE EN VERRE TEMPRE OU BOIS LAMINÉ; TUYAU EN ACIER PORTE SAUCISSONS
3. POSTERIEUR EN BOIS LAMINÉ OU MIROIR
4. SUPPORT POUR RÉGLAGE ÉTAGÈRES
5. MODULES EN ACIER INOX AISI 304 SCOTCH BRITE, PORTE BATTANT ET TRÉMIE L. 50/100/125/150
6. PORTES EN ACIER AISI 304 SCOTCH BRITE
7. PLINTHE EN ACIER INOX AISI 304 SCOTCH BRITE
8. STRUCTURE DU MODULE EN ACIER INOX AISI SCOTCH BRITE
9. INSERTION ÉVIER SOUDÉ SUR L'ÉTAGE DE DIFFÉRENTES DIMENSIONS

FINITURE IN LAMINATO DI LEGNO

FINISHING IN ROLLED WOOD
FINITION EN LAMINÉ DE BOIS

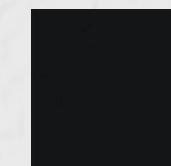

NERO
BLACK
NOIR

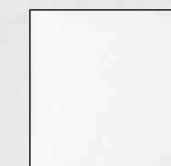

BIANCO
WHITE
BLANC

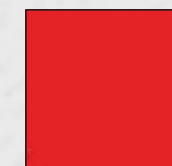

ROSSO
RED
ROUGE

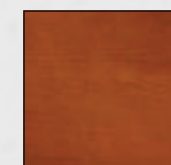

CILIEGIO
CHERRY
CERISIER



ROVERE
OAK
ROUVRE



NOCA
WALNUT
NOIX

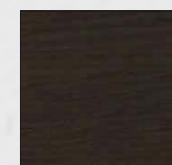

WENGE'

INOX PACK®
DIVISIONE GRANDI IMPIANTI

ARCA
CUCINE
I T A L I A

GRUPPO INOX PACK S.P.A.

Contrada Taiano, 7 - 64010 Controguerra (TE) - Italia
Tel. +39 0861 809948 - Fax +39 0861 89217
info@inoxpack.it - www.inoxpack.it
info@arcacucine.it - www.arcacucine.it